

**Features:**

- Precision performance
- High stability
- Tolerances as low as 0.1%
- Temperature coefficient of resistance as low as  $\pm 50$  ppm/ $^{\circ}$ C
- RoHS compliant, REACH compliant, and halogen free
- 0402 and 0603 sizes are AEC-Q200 compliant



Electrical Specifications							
Type/Code	Power Rating (W) @ 70 $^{\circ}$ C	Maximum Working Voltage (V) <sup>(1)</sup>	Maximum Overload Voltage (V)	TCR (ppm/ $^{\circ}$ C)	Ohmic Range ( $\Omega$ ) and Tolerance		
					0.1%	0.5%	1%
RGC0201	0.05	25	50	$\pm 200$	-	10 - 10M	-
RGC0402	0.063	50	100	$\pm 50$	-	100 - 1M	
				$\pm 100$	-	10 - 1M	1 - 1M
				$\pm 200$	-	1.02M - 10M	-
RGC0603	0.1	75	150	$\pm 50$	10 - 1M	10 - 10M	
				$\pm 100$	10 - 1M		1 - 10M
				$\pm 200$	-	1.02M - 10M	-
RGC0805	0.125	150	300	$\pm 50$	10 - 1M	10 - 10M	
				$\pm 100$	10 - 1M		1 - 10M
				$\pm 200$	-	1.02M - 10M	
RGC1206	0.25	200	400	$\pm 50$	10 - 1M	10 - 10M	
				$\pm 100$	10 - 1M		1 - 10M
				$\pm 200$	-	1.02M - 10M	
RGC1210	0.25	200	400	$\pm 100$	-	-	1 - 9.76
				$\pm 50$	10 - 1M	10 - 10M	
	0.33	200	400	$\pm 100$	10 - 1M		10 - 10M
				$\pm 200$	-	1.02M - 10M	-
RGC2010	0.75	200	400	$\pm 50$	10 - 1M	10 - 10M	
				$\pm 100$	10 - 1M		1 - 10M
				$\pm 200$	-	1.02M - 10M	
RGC2512	1	200	400	$\pm 100$	-	-	1 - 9.76
		250	500	$\pm 50$	10 - 1M	10 - 10M	
	$\pm 100$			10 - 1M		10 - 10M	
	$\pm 200$	-	1.02M - 10M				

Note: (1) Lesser of  $\sqrt{(P \cdot R)}$  or maximum working voltage

**Mechanical Specifications**

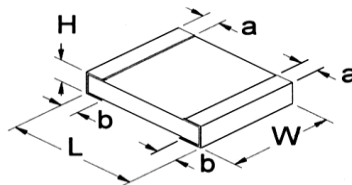

Type/Code	Typical Unit Weight (mg)	L Body Length	W Body Width	H Body Height	a Top Termination	b Bottom Termination	Unit
RGC0201	0.15	0.024 $\pm$ 0.001	0.012 $\pm$ 0.001	0.009 $\pm$ 0.001	0.006 $\pm$ 0.002	0.006 $\pm$ 0.002	inches
		0.60 $\pm$ 0.03	0.30 $\pm$ 0.03	0.23 $\pm$ 0.03	0.15 $\pm$ 0.05	0.15 $\pm$ 0.05	mm

Mechanical Specifications (cont.)							
Type/Code	Weight (g) (1000 pc.)	L Body Length	W Body Width	H Body Height	a Top Termination	b Bottom Termination	Unit
RGC0402	0.62	0.039 ± 0.004 1.00 ± 0.10	0.020 ± 0.002 0.50 ± 0.05	0.012 ± 0.004 0.30 ± 0.10	0.008 ± 0.004 0.20 ± 0.10	0.010 ± 0.006 0.25 ± 0.15	inches mm
RGC0603	2.0	0.063 ± 0.004 1.60 ± 0.10	0.031 ± 0.004 0.80 ± 0.10	0.018 ± 0.004 0.45 ± 0.10	0.012 ± 0.008 0.30 ± 0.20	0.012 ± 0.008 0.30 ± 0.20	inches mm
RGC0805	4.4	0.079 ± 0.004 2.00 ± 0.10	0.049 ± 0.004 1.25 ± 0.10	0.020 ± 0.004 0.50 ± 0.10	0.016 ± 0.010 0.40 ± 0.25	0.016 ± 0.008 0.40 ± 0.20	inches mm
RGC1206	8.9	0.122 ± 0.006 3.10 ± 0.15	0.061 ± 0.004 1.55 ± 0.10	0.024 ± 0.006 0.60 ± 0.15	0.020 ± 0.010 0.50 ± 0.25	0.020 ± 0.012 0.50 ± 0.30	inches mm
RGC1210	16.0	0.126 ± 0.010 3.20 ± 0.25	0.102 ± 0.006 2.60 ± 0.15	0.022 ± 0.004 0.55 ± 0.10	0.020 ± 0.010 0.50 ± 0.25	0.020 ± 0.008 0.50 ± 0.20	inches mm
RGC2010	24.2	0.197 ± 0.008 5.00 ± 0.20	0.098 ± 0.006 2.50 ± 0.15	0.022 ± 0.004 0.55 ± 0.10	0.024 ± 0.010 0.60 ± 0.25	0.024 ± 0.012 0.60 ± 0.30	inches mm
RGC2512	39.4	0.250 ± 0.008 6.35 ± 0.20	0.124 ± 0.008 3.15 ± 0.20	0.022 ± 0.004 0.55 ± 0.10	0.024 ± 0.010 0.60 ± 0.25	0.024 ± 0.012 0.60 ± 0.30	inches mm

Performance Characteristics			
Test	Test Method	Test Specification	Test Condition
Temperature Coefficient of Resistance	JIS-C-5201-1 4.8 IEC-60115-1 4.8	As specified.	-55 +125°C, 25°C is the reference temperature
Short Time Overload	JIS-C-5201-1 4.13 IEC-60115-1 4.13	±(1% + 0.05Ω)	RCWV*2.5 or max. overload voltage whichever is lower for 5 seconds; 2 seconds for high power series
Insulation resistance	JIS-C-5201-1 4.6 IEC-60115-1 4.6	≥ 10G	Max. overload voltage for 1 minute
Endurance	JIS-C-5201-1 4.25 IEC-60115-1 4.25.1	±(1% + 0.1Ω)	70 ± 2°C, RCWV for 1000 hours with 1.5 hours "ON" and 0.5 hour "OFF"
Damp Heat with Load	JIS-C-5201-1 4.24 IEC-60115-1 4.24	±(1% + 0.1Ω)	40 ± 2°C, 90 ~ 95% R.H., RCWV for 1000 hours with 1.5 hour "ON" and 0.5 hour "OFF"
Dry Heat	JIS-C-5201-1 4.23 IEC-60115-1 4.23.2	±(1% + 0.05Ω)	at +125 / +155°C for 1000 hours
Bending Strength	JIS-C-5201-1 4.33 IEC-60115-1 4.33	±(1% + 0.05Ω)	Bending once for 5 seconds 2010, 2512 sizes: 2 mm; other sizes: 3 mm
Solderability	JIS-C-5201-1 4.17 IEC-60115-1 4.17	95% minimum coverage	245 ± 5°C for 3 seconds
Resistance to Soldering Heat	JIS-C-5201-1 4.18 IEC-60115-1 4.18	±(0.5% + 0.05Ω)	260 ± 5°C for 10 seconds
Voltage Proof	JIS-C-5201-1 4.7 IEC-60115-1 4.7	No breakdown or flashover	1.42 times max. operating voltage for 1 minute
Leaching	JIS-C-5201-1 4.18 IEC-60068-2-58 8.2.1	Individual leaching area ≤ 5% Total leaching area ≤ 10%	260 ± 5°C for 30 seconds
Rapid Change of Temperature	JIS-C-5201-1 4.19 IEC-60115-1 4.19	±(0.5% + 0.05Ω)	-55 to +125°C / +155°C, 5 cycles

RCWV (Rated Continuous Working Voltage) =  $\sqrt{P \cdot R}$  or max. operating voltage whichever is lower

Recommended storage temperature: 25 ± 3°C; humidity < 80% RH

Operating temperature range for 0201 is -55 to +125°C

Operating temperature range for 0402 - 2512 is -55 to 155°C

Power Derating Chart:

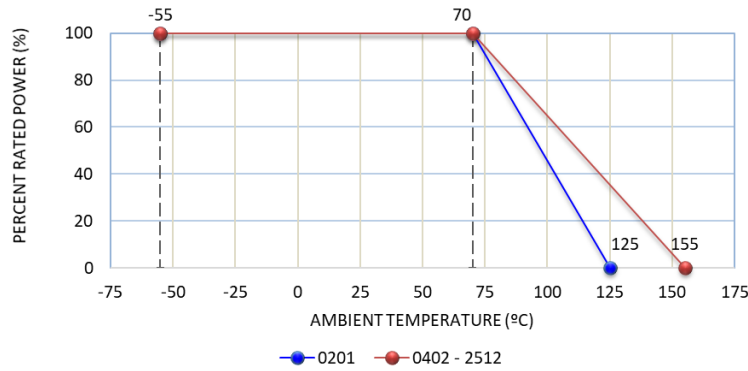

**Recommended Pad Layout**

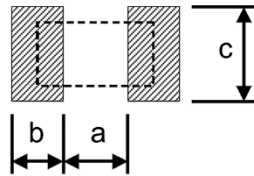

Type/Code	a	b	c	Unit
RGC0201	0.012	0.010	0.012	inches
	0.30	0.25	0.30	mm
RGC0402	0.020	0.018	0.024	inches
	0.50	0.45	0.60	mm
RGC0603	0.035	0.024	0.035	inches
	0.90	0.60	0.90	mm
RGC0805	0.047	0.028	0.051	inches
	1.20	0.70	1.30	mm
RGC1206	0.079	0.035	0.063	inches
	2.00	0.90	1.60	mm
RGC1210	0.079	0.035	0.110	inches
	2.00	0.90	2.80	mm
RGC2010	0.150	0.035	0.110	inches
	3.80	0.90	2.80	mm
RGC2512	0.193	0.063	0.138	inches
	4.90	1.60	3.50	mm

**Recommended Solder Profile**

This information is intended as a reference for solder profiles for Stackpole resistive components. These profiles should be compatible with most soldering processes. These are only recommendations. Actual numbers will depend on board density, geometry, packages used, etc., especially those cells labeled with “\*”.

**100% Matte Tin / RoHS Compliant Terminations**

Soldering iron recommended temperatures: 330 to 350°C with minimum duration.  
Maximum number of reflow cycles: 3.

Wave Soldering			
Description	Maximum	Recommended	Minimum
Preheat Time	80 seconds	70 seconds	60 seconds
Temperature Diff.	140°C	120°C	100°C
Solder Temp.	260°C	250°C	240°C
Dwell Time at Max.	10 seconds	5 seconds	*
Ramp DN (°C/sec)	N/A	N/A	N/A

Temperature Diff. = Difference between final preheat stage and soldering stage.

Convection IR Reflow			
Description	Maximum	Recommended	Minimum
Ramp Up (°C/sec)	3°C/sec	2°C/sec	*
Dwell Time > 217°C	150 seconds	90 seconds	60 seconds
Solder Temp.	260°C	245°C	*
Dwell Time at Max.	30 seconds	15 seconds	10 seconds
Ramp DN (°C/sec)	6°C/sec	3°C/sec	*

**Recommended Resistor Reflow Profile**

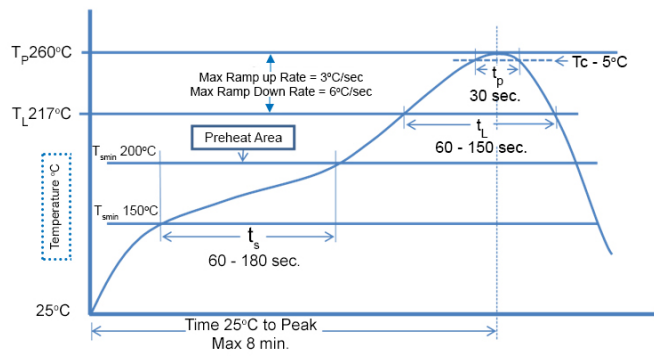

**Reel Specifications**

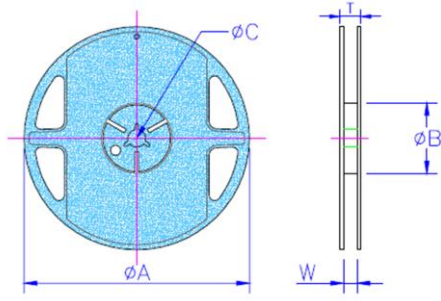

Type/Code	Packaging Description	Tape Width	Reel Diameter	A	B	C	W	T	Unit	
RGC0201	Paper	8 mm	7 inches	7.028 ± 0.059	2.362 ± 0.039	0.512 ± 0.008	0.354 ± 0.020	0.492 ± 0.020	inches	
RGC0402				178.50 ± 1.50	60.00 ± 1.00	13.00 ± 0.20	9.00 ± 0.50	12.50 ± 0.50	mm	
RGC0603										
RGC0805										
RGC1206										
RGC1210										
RGC2010	Plastic	12 mm	7 inches	7.028 ± 0.059	2.362 ± 0.039	0.512 ± 0.020	0.512 ± 0.020	0.610 ± 0.020	inches	
RGC2512				178.50 ± 1.50	60.00 ± 1.00	13.00 ± 0.50	13.00 ± 0.50	15.50 ± 0.50	mm	

**Packaging Specifications – Paper Tape**

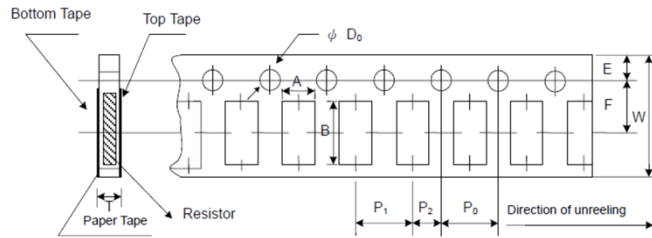

Type/Code	A	B	W	E	F	Unit
RGC0201	0.015 ± 0.002	0.027 ± 0.002	0.315 ± 0.008	0.069 ± 0.004	0.138 ± 0.002	inches
	0.38 ± 0.05	0.68 ± 0.05	8.00 ± 0.20	1.75 ± 0.10	3.50 ± 0.05	mm
RGC0402	0.026 ± 0.004	0.045 ± 0.004	0.315 ± 0.008	0.069 ± 0.004	0.138 ± 0.002	inches
	0.65 ± 0.10	1.15 ± 0.10	8.00 ± 0.20	1.75 ± 0.10	3.50 ± 0.05	mm
RGC0603	0.043 ± 0.004	0.075 ± 0.004	0.315 ± 0.008	0.069 ± 0.004	0.138 ± 0.002	inches
	1.10 ± 0.10	1.90 ± 0.10	8.00 ± 0.20	1.75 ± 0.10	3.50 ± 0.05	mm
RGC0805	0.063 ± 0.004	0.094 ± 0.008	0.315 ± 0.008	0.069 ± 0.004	0.138 ± 0.002	inches
	1.60 ± 0.10	2.40 ± 0.20	8.00 ± 0.20	1.75 ± 0.10	3.50 ± 0.05	mm
RGC1206	0.075 ± 0.004	0.138 ± 0.008	0.315 ± 0.008	0.069 ± 0.004	0.138 ± 0.002	inches
	1.90 ± 0.10	3.50 ± 0.20	8.00 ± 0.20	1.75 ± 0.10	3.50 ± 0.05	mm
Type/Code	P0	P1	P2	D0	T	Unit
RGC0201	0.157 ± 0.004	0.079 ± 0.002	0.079 ± 0.002	0.059 ± 0.004	0.017 ± 0.008	inches
	4.00 ± 0.10	2.00 ± 0.05	2.00 ± 0.05	1.50 ± 0.10	0.42 ± 0.20	mm
RGC0402	0.157 ± 0.004	0.079 ± 0.002	0.079 ± 0.002	0.059 ± 0.004	0.018 ± 0.004	inches
	4.00 ± 0.10	2.00 ± 0.05	2.00 ± 0.05	1.50 ± 0.10	0.45 ± 0.10	mm
RGC0603	0.157 ± 0.004	0.157 ± 0.002	0.079 ± 0.002	0.059 ± 0.004	0.028 ± 0.004	inches
	4.00 ± 0.10	4.00 ± 0.05	2.00 ± 0.05	1.50 ± 0.10	0.70 ± 0.10	mm
RGC0805	0.157 ± 0.004	0.157 ± 0.002	0.079 ± 0.002	0.059 ± 0.004	0.033 ± 0.004	inches
	4.00 ± 0.10	4.00 ± 0.05	2.00 ± 0.05	1.50 ± 0.10	0.85 ± 0.10	mm
RGC1206	0.157 ± 0.004	0.157 ± 0.002	0.079 ± 0.002	0.059 ± 0.004	0.033 ± 0.004	inches
	4.00 ± 0.10	4.00 ± 0.05	2.00 ± 0.05	1.50 ± 0.10	0.85 ± 0.10	mm

**Packaging Specifications – Plastic Tape**

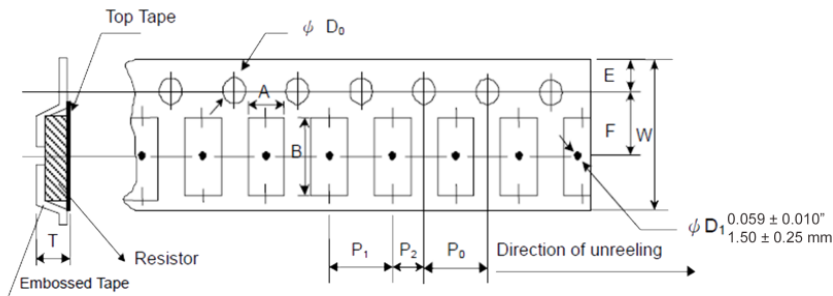

Type/Code	A	B	W	E	F	Unit
RGC2010	0.110 ± 0.004	0.217 ± 0.004	0.472 ± 0.012	0.069 ± 0.004	0.217 ± 0.002	inches
	2.80 ± 0.10	5.50 ± 0.10	12.00 ± 0.30	1.75 ± 0.10	5.50 ± 0.05	mm
RGC2512	0.138 ± 0.004	0.264 ± 0.004	0.472 ± 0.012	0.069 ± 0.004	0.217 ± 0.002	inches
	3.50 ± 0.10	6.70 ± 0.10	12.00 ± 0.30	1.75 ± 0.10	5.50 ± 0.05	mm
Type/Code	P0	P1	P2	D0	T	Unit
RGC2010	0.157 ± 0.004	0.157 ± 0.004	0.079 ± 0.002	0.059 ± 0.004	0.047 ± 0.000	inches
	4.00 ± 0.10	4.00 ± 0.10	2.00 ± 0.05	1.50 ± 0.10	1.20 ± 0.00	mm
RGC2512	0.157 ± 0.004	0.157 ± 0.004	0.079 ± 0.002	0.059 ± 0.004	0.047 ± 0.000	inches
	4.00 ± 0.10	4.00 ± 0.10	2.00 ± 0.05	1.50 ± 0.10	1.20 ± 0.00	mm

**Part Marking Instructions**

**E96 and E24 Values For Sizes 0805 to 2512**

The nominal resistance is marked on the surface of the overcoating with the use of **four character markings.**

1. Values <100Ω will use "R" as the decimal holder



1.21Ω



1MΩ

**E24 Values For Size 0603**

The nominal resistance is marked on the surface of the overcoating with the use of **three character markings.**

1. Values between 1Ω and 9.1Ω will use "R" as the decimal holder.
2. Values ≥10Ω will use no decimal holder
3. Values that are both E24 and E96 follow E96 marking rules.

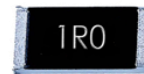

1Ω



220Ω

**E96 Values For Size 0603**

A two character number is assigned to each standard R-Value (E96) as shown in the chart below. This is followed by one alpha character which is used as a multiplier.

Each letter from "Y" - "F" represents a specific multiplier.

Alpha Character = Multiplier		Chip Marking	Value
Y = 0.1	C = 1000	01B =	10.0 x 100 = 1 KΩ
X = 1	D = 10000	25C =	17.8 x 1000 = 17.8 KΩ
A = 10	E = 100000	93D =	90.9 x 10000 = 909 KΩ
B = 100	F = 1000000		

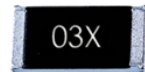

10.5Ω

**E96**

#	R-Value	#	R-Value	#	R-Value	#	R-Value	#	R-Value	#	R-Value
01	10.0	17	14.7	33	21.5	49	31.6	65	46.4	81	68.1
02	10.2	18	15.0	34	22.1	50	32.4	66	47.5	82	69.8
03	10.5	19	15.4	35	22.6	51	33.2	67	48.7	83	71.5
04	10.7	20	15.8	36	23.2	52	34.0	68	49.9	84	73.2
05	11.0	21	16.2	37	23.7	53	34.8	69	51.1	85	75.0
06	11.3	22	16.5	38	24.3	54	35.7	70	52.3	86	76.8
07	11.5	23	16.9	39	24.9	55	36.5	71	53.6	87	78.7
08	11.8	24	17.4	40	25.5	56	37.4	72	54.9	88	80.6
09	12.1	25	17.8	41	26.1	57	38.3	73	56.2	89	82.5
10	12.4	26	18.2	42	26.7	58	39.2	74	57.6	90	84.5
11	12.7	27	18.7	43	27.4	59	40.2	75	59.0	91	86.6
12	13.0	28	19.1	44	28.0	60	41.2	76	60.4	92	88.7
13	13.3	29	19.6	45	28.7	61	42.2	77	61.9	93	90.9
14	13.7	30	20.0	46	29.4	62	43.2	78	63.4	94	93.1
15	14.0	31	20.5	47	30.1	63	44.2	79	64.9	95	95.3
16	14.3	32	21.0	48	30.9	64	45.3	80	66.5	96	97.6

Note: Sizes 0201 and 0402 are unmarked.

**RoHS Compliance**

Stackpole Electronics has joined the worldwide effort to reduce the amount of lead in electronic components and to meet the various regulatory requirements now prevalent, such as the European Union’s directive regarding “Restrictions on Hazardous Substances” (RoHS 3). As part of this ongoing program, we periodically update this document with the status regarding the availability of our compliant components. All our standard part numbers are compliant to EU Directive 2011/65/EU of the European Parliament as amended by Directive (EU) 2015/863/EU as regards the list of restricted substances.

RoHS Compliance Status						
Standard Product Series	Description	Package / Termination Type	Standard Series RoHS Compliant	Lead-Free Termination Composition	Lead-Free Mfg. Effective Date (Std Product Series)	Lead-Free Effective Date Code (YY/WW)
RGC	Precision Thick Film Chip Resistor	SMD	YES(1)	100% Matte Sn over Ni	Jul-04	04/27

Note (1): RoHS Compliant by means of exemption 7c-l.

**“Conflict Metals” Commitment**

We at Stackpole Electronics, Inc. are joined with our industry in opposing the use of metals mined in the “conflict region” of the eastern Democratic Republic of the Congo (DRC) in our products. Recognizing that the supply chain for metals used in the electronics industry is very complex, we work closely with our own suppliers to verify to the extent possible that the materials and products we supply do not contain metals sourced from this conflict region. As such, we are in compliance with the requirements of Dodd-Frank Act regarding Conflict Minerals.

**Compliance to “REACH”**

We certify that all passive components supplied by Stackpole Electronics, Inc. are SVHC (Substances of Very High Concern) free and compliant with the requirements of EU Directive 1907/2006/EC, “The Registration, Evaluation, Authorization and Restriction of Chemicals”, otherwise referred to as REACH. Contact us for complete list of REACH Substance Candidate List.

**Environmental Policy**

It is the policy of Stackpole Electronics, Inc. (SEI) to protect the environment in all localities in which we operate. We continually strive to improve our effect on the environment. We observe all applicable laws and regulations regarding the protection of our environment and all requests related to the environment to which we have agreed. We are committed to the prevention of all forms of pollution.

**How to Order**

